

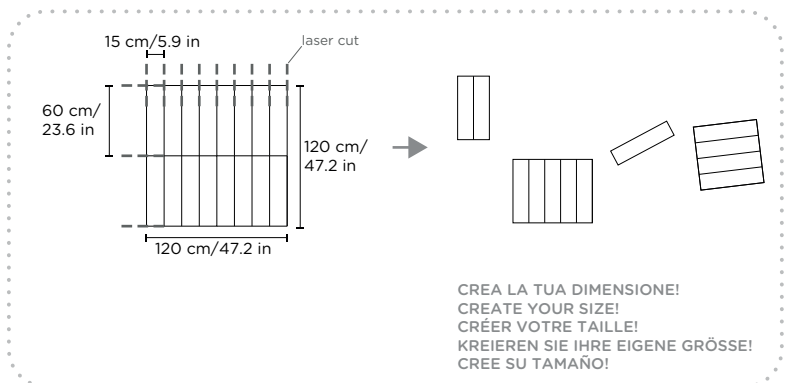

# ECOWALL

IT	EN	FR	DE	ES
<b>NOME:</b> ECOWall	<b>NAME:</b> ECOWall	<b>DENOMINATION:</b> ECOWall	<b>NAME:</b> ECOWall	<b>NOMBRE:</b> ECOWall
<b>DESCRIZIONE:</b> Pannello monomaterico fonoassorbente termoformato	<b>DESCRIPTION:</b> Single-material sound absorbing panel thermoformed	<b>DESCRIPTION:</b> Panneau absorbant acoustique thermoformé	<b>BESCHREIBUNG:</b> Thermogeformte Schallschutzplatte aus Monomaterial	<b>DESCRIPCIÓN:</b> Panel monomaterico acústico termoformado
<b>APPLICAZIONI:</b> • Muro con velcro o calamite • Soffitto con velcro o calamite • Soffitto pendinato con cavi	<b>APPLICATIONS:</b> • Wall with velcro or magnets • Ceiling with velcro or magnets • Suspended ceiling with cable	<b>APPLICATION:</b> • Mur avec velcro ou aimants • Plafond avec velcro ou aimants • Plafond suspendu avec câbles	<b>ANWENDUNG:</b> • Wand: Klettverschluss, Magneten • Decke: Klettverschluss, Magneten • Abgehängte Decke mit Kabel	<b>APLICACIONES:</b> • Pared con velcro o imanes • Techo con velcro o imanes • Techo suspendido con cable
<b>DIMENSIONI:</b> L 14,9   29,8   44,7   59,5   119 x H 14,9   29,8   44,7   59,5   119 x SP 2 cm L 5.9   11.7   17.6   23.4   46.8 x H 5.9   11.7   17.6   23.4   46.8 x SP 0.79 in <i>I pannelli potranno avere differenze di spessore dovute alla tipologia del materiale</i>	<b>DIMENSIONS:</b> L 14,9   29,8   44,7   59,5   119 x H 14,9   29,8   44,7   59,5   119 x THK 2 cm L 5.9   11.7   17.6   23.4   46.8 x H 5.9   11.7   17.6   23.4   46.8 x THK 0.79 in <i>Panels may have differences in thickness due to the type of material</i>	<b>DIMENSIONS:</b> L 14,9   29,8   44,7   59,5   119 x H 14,9   29,8   44,7   59,5   119 x THK 2 cm L 5.9   11.7   17.6   23.4   46.8 x H 5.9   11.7   17.6   23.4   46.8 x THK 0.79 in <i>Les panneaux peuvent avoir des différences d'épaisseur dues à la typologie du matériau</i>	<b>DIMENSION:</b> L 14,9   29,8   44,7   59,5   119 x H 14,9   29,8   44,7   59,5   119 x D 2 cm L 5.9   11.7   17.6   23.4   46.8 x H 5.9   11.7   17.6   23.4   46.8 x D 0.79 in <i>Platten können aufgrund der Material Typologie Dickenunterschiede aufweisen</i>	<b>DIMENSIONES:</b> L 14,9   29,8   44,7   59,5   119 x H 14,9   29,8   44,7   59,5   119 x ESP 2 cm L 5.9   11.7   17.6   23.4   46.8 x H 5.9   11.7   17.6   23.4   46.8 x ESP 0.79 in <i>Los paneles pueden tener diferencias de grosor debido a la tipología del material</i>
<b>PESO:</b> 2.9 kg/m <sup>2</sup> 0.59 lb/ft <sup>2</sup>	<b>WEIGHT:</b> 2.9 kg/m <sup>2</sup> 0.59 lb/ft <sup>2</sup>	<b>POIDS:</b> 2.9 kg/m <sup>2</sup> 0.59 lb/ft <sup>2</sup>	<b>GEWICHT:</b> 2.9 kg/m <sup>2</sup> 0.59 lb/ft <sup>2</sup>	<b>PESO:</b> 2.9 kg/m <sup>2</sup> 0.59 lb/ft <sup>2</sup>
<b>COMPOSIZIONE:</b> • Anima: Materiale fonoassorbente composto da materiale riciclato, 100% fibre in poliestere Reazione al fuoco: <b>CL1</b> Classe fumo: F1 Certificato: Oekotex	<b>COMPOSITION:</b> • Soul: Sound absorbing material made of 100% recycled material, of polyester fibers Reaction to fire: <b>CL1</b> Smoke class: F1 Certificate: Oekotex	<b>COMPOSITION:</b> • Âme: Matériau absorbant acoustique composé de fibres discontinues 100% polyester Réaction au feu: <b>CL1</b> Réaction à la fumée: F1 Certificat: Oekotex	<b>ZUSAMMENSETZUNG:</b> • Äme: 100% recyceltes schallschluckendes Material, aus Polyesterfaser. Brandverhalten: <b>CL1</b> Rauchklasse: F1 Bescheinigung : Oekotex	<b>COMPOSICIÓN:</b> • Alma: material acústico compuesto de material 100% reciclado, fibra de poliéster Reacción al fuego: <b>CL1</b> Clase de fumo: F1 Certificado: Oekotex
<b>FINITURE:</b> • <b>CAT A</b> - Trevira CS, ECOfelt, PETfelt, PETfabric, PETcolor, Velvet • <b>CAT B</b> - Tweed, Trace	<b>FINISHING:</b> • <b>CAT A</b> - Trevira CS, ECOfelt, PETfelt, PETfabric, PETcolor, Velvet • <b>CAT B</b> - Tweed, Trace	<b>REVÊTEMENT:</b> • <b>CAT A</b> - Trevira CS, ECOfelt, PETfelt, PETfabric, PETcolor, Velvet • <b>CAT B</b> - Tweed, Trace	<b>FINISH:</b> • <b>CAT A</b> - Trevira CS, ECOfelt, PETfelt, PETfabric, PETcolor, Velvet • <b>CAT B</b> - Tweed, Trace	<b>ACABADO DEL PANEL:</b> • <b>CAT A</b> - Trevira CS, ECOfelt, PETfelt, PETfabric, PETcolor, Velvet • <b>CAT B</b> - Tweed, Trace
<b>RICICLABILITÀ:</b> Pannello di materiale riciclato e riciclabile alla fine della sua vita, senza separare anima e finitura	<b>RECYCLABILITY:</b> Recycled material panel recyclable at the end of his life, without dividing soul and finish	<b>RECYCLAGE:</b> Panneau recyclé et recyclable en fin de vie, sans séparer les composants	<b>RECYCLINGFÄHIGKEIT:</b> Das Paneel besteht aus recyceltem Material und es kann wieder recycelt sein am Ende seines Leben	<b>RECICLABILIDAD:</b> Panel de material reciclado y reciclable al final de su vida, sin tener que separar el alma y el forro.
<b>MANUTENZIONE:</b> Pannello pulibile con detergenti specifici	<b>MAINTENANCE:</b> Cleanable panel with specific detergents	<b>ENTRETIEN:</b> Le panneau peut être nettoyé avec des détergents adaptés	<b>INSTANDHALTUNG:</b> Man kann das Paneel mit spezifischer Reinigungsmitteln säubern	<b>MANTENIMIENTO:</b> Panel limpiable con detergentes específicos.
<b>REAZIONE AL FUOCO:</b> B-s2, d0	<b>FIRE REACTION:</b> B-s2, d0	<b>RÉACTION AU FEU:</b> B-s2, d0	<b>Brandverhalten - Klasse:</b> B-s2, d0	<b>REACCIÓN AL FUEGO:</b> B-s2, d0
<b>MARCATURA CE:</b> B-s1, d0	<b>CE MARK:</b> B-s1, d0	<b>CE MARQ:</b> B-s1, d0	<b>KENNZEICHNUNG CE:</b> B-s1, d0	<b>MARCADO CE:</b> B-s1, d0
<b>CERTIFICAZIONI ECOLOGICHE:</b> GREENGUARD GREENGUARD GOLD	<b>GREEN LABELS:</b> GREENGUARD GREENGUARD GOLD	<b>ÉTIQUETTES ÉCOLOGIQUE:</b> GREENGUARD GREENGUARD GOLD	<b>ÖKOLOGISCHE ZERTIFIZIERUNG:</b> GREENGUARD GREENGUARDGOLD	<b>CERTIFICACIONES ECOLÓGICAS:</b> GREENGUARD GREENGUARDGOLD
<b>FONO ASSORBIMENTO:</b> UNI EN ISO 354: 2003 UNI EN ISO 11654: 1998	<b>SOUND ABSORPTION:</b> UNI EN ISO 354: 2003 UNI EN ISO 11654: 1998	<b>ABSORPTION DU SON:</b> UNI EN ISO 354: 2003 UNI EN ISO 11654: 1998	<b>SCHALLABSORPTION:</b> UNI EN ISO 354: 2003 UNI EN ISO 11654: 1998	<b>ABSORCIÓN DE SONIDO:</b> UNI EN ISO 354: 2003 UNI EN ISO 11654: 1998

$$\alpha_w = 0,75 \mid \text{NRC} = 0,70$$

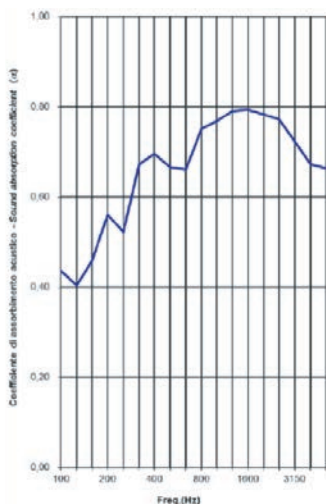



foro singolo + cavo regolabile | single hole + adjustable cable  
seul trou + câble réglable | einzelnes Loch + verstellbares Kabel  
solo agujero + cable ajustable

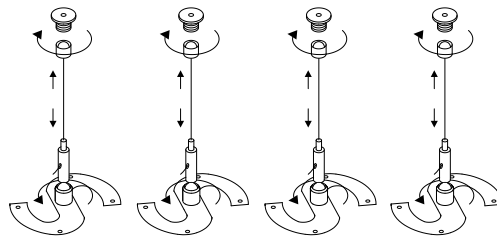

**SM-4-F**

3ml

3.28yd

NE

calamita + disco + cavo regolabile | magnet + disk + adjustable cable  
aimant + disque + câble réglable | Magnet + Scheibe + verstellbares Kabel  
imán + disco + cable ajustable

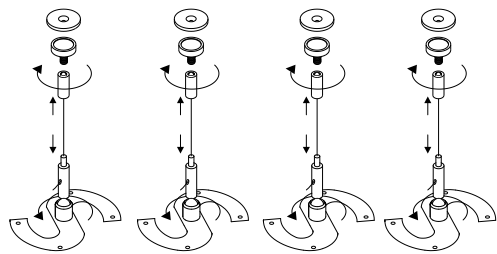

**SM-4-M**

3ml

3.28yd

NE



COD **EW-60.60/4**

CM 59,5x59,5x2

IN 23.4x23.4x0.8

CO **CAT A**

€

CO **CAT B**

€

**SET of 4**  
stesso colore  
same color  
du même couleur  
gleiche Farbe  
mismo color



Front: CAT A/B

Back: Black

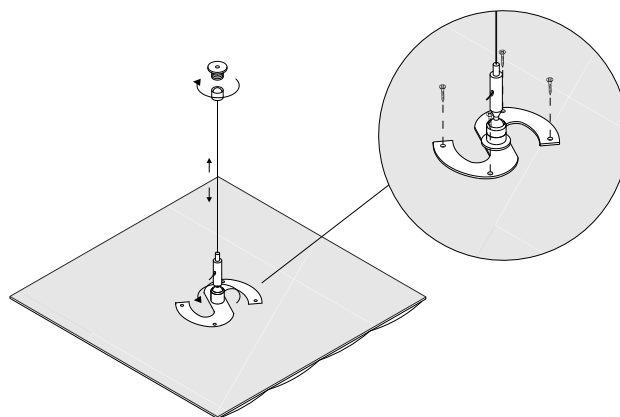
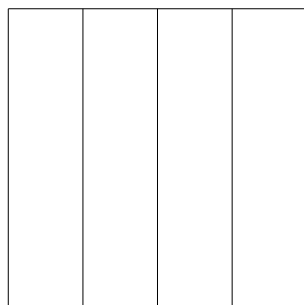
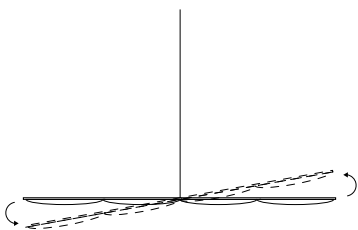

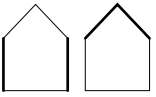
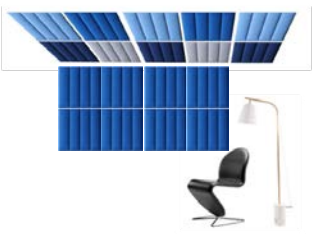

COD **EW-30.60/V/8**  
 CM 30x59,5x2  
 IN 11.8x23.4x0.8  
 CO CAT A  
 €  
 CO CAT B  
 €

**SET of 8**  
 stesso colore  
 same color  
 du même couleur  
 gleiche Farbe  
 mismo color

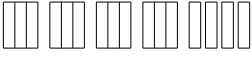

COD **EW-45.60/V/4**  
 CM 45+15x59,5x2  
 IN 17.7+5.9x23.4x0.8  
 CO CAT A  
 €  
 CO CAT B  
 €

**SET of 4 + 4**  
**(45x4 | 15x4)**  
 stesso colore  
 same color  
 du même couleur  
 gleiche Farbe  
 mismo color

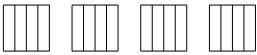

COD **EW-60.60/V/4**  
 CM 59,5x59,5x2  
 IN 23.4x23.4x0.8  
 CO CAT A  
 €  
 CO CAT B  
 €

**SET of 4**  
 stesso colore  
 same color  
 du même couleur  
 gleiche Farbe  
 mismo color



velcro adesivo incluso  
 selfadhesive velcro included  
 bande Velcro inclus  
 Klettband enthalten  
 cinta de velcro incluidas

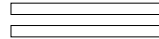

COD **EW-120.60/V/2**  
 CM 119x59,5x2  
 IN 46.8x23.4x0.8  
 CO CAT A  
 €  
 CO CAT B  
 €

**SET of 2**  
 stesso colore  
 same color  
 du même couleur  
 gleiche Farbe  
 mismo color

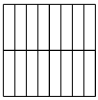

COD **EW-120.120/V**  
 CM 119x119x2  
 IN 46.8x46.8x0.8  
 CO CAT A  
 €  
 CO CAT B  
 €

**Ideali se vuoi affiancare  
 i pannelli:**

*Ideal if you want to place  
 panels side by side:*

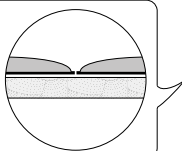

Front: CAT A/B

Back: Black

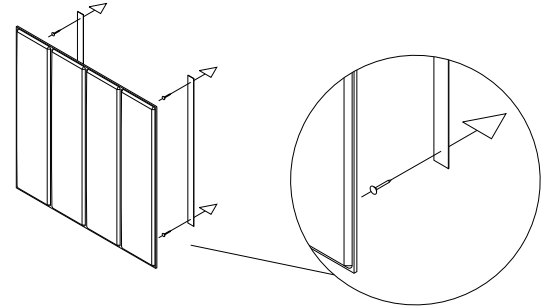
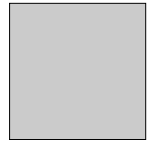
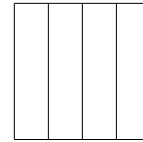

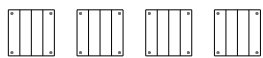
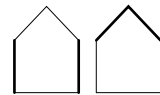
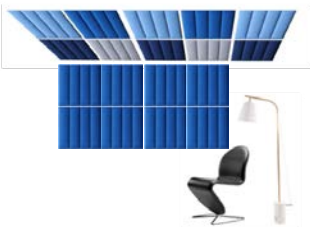

[4+4+4+4]

COD	<b>EW-60.60/M/4</b>
CM	59,5xH59,5x2
IN	23.4xH23.4x0.8
CO	CAT A
€	
CO	CAT B
€	

**SET of 4**  
stesso colore  
same color  
du même couleur  
gleiche Farbe  
mismo color



Front: CAT A/B

Back: Black

calamita da avvitare al pannello + disco in metallo a muro - INCLUSI  
magnet screwed on panel + wall-mounted metal disk - INCLUDED  
aimant vissé sur panneau + disque métallique mural - INCLUS  
Magnet auf Platte verschraubt + Wand-Metallscheibe - ENTHALTEN  
imán da fijarse al panel + disco de metal montado en la pared - INCLUIDAS

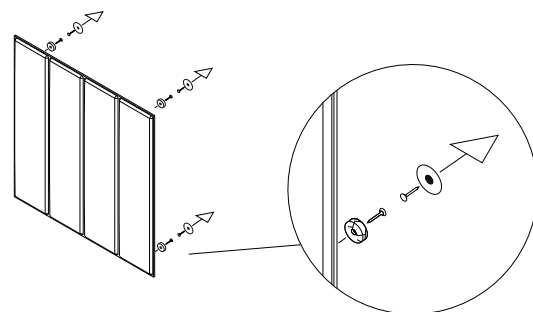
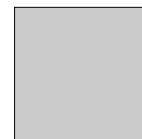
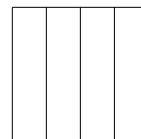
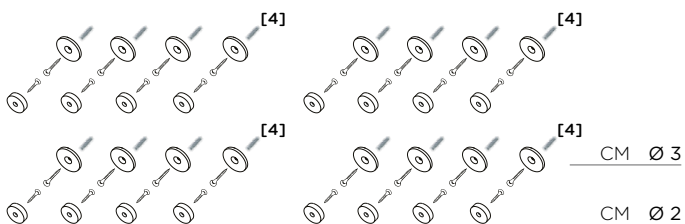

**Possiamo esserti di aiuto?! Guarda l'esempio:**  
*Can we help you?! Look at the example:*

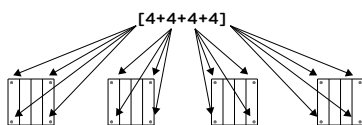

COD	<b>EW-60.60/M/4</b>
CM	60xH60x2
IN	23.6xH23.6x0.8
CO	CAT A
€	
CO	CAT B
€	

+

codice articolo ferramenta INCLUSO  
hardware article code INCLUDED  
code article quincailleries INCLUS  
Hardware-Artikelcode INKLUSIVE  
código de artículo de hardware INCLUIDO

