





# LAMELLAE

IT	EN	FR	DE	ES
<b>NOME:</b> LAMELLAE	<b>NAME:</b> LAMELLAE	<b>DENOMINATION:</b> LAMELLAE	<b>NAME:</b> LAMELLAE	<b>NOMBRE:</b> LAMELLAE
<b>DESCRIZIONE:</b> Lamelles in feltro rigido fonoaassorbenti e anti riverberanti	<b>DESCRIPTION:</b> Sound-absorbing and anti-reverberation Hard felt Lamellae	<b>DESCRIPTION:</b> Lamelles en feutre rigide absorbant les sons et anti-reflets	<b>BESCHREIBUNG:</b> Harte Filzplatten Schalldämmende e anti-Nachhall	<b>DESCRIPCIÓN:</b> Listones en fieltro rígido de absorción acústico e anti-reverberación
<b>APPLICAZIONI:</b> • Muro con struttura di supporto e colla	<b>APPLICATIONS:</b> • Wall with support structure and glue	<b>APPLICATION:</b> • Mur avec support et colle	<b>ANWENDUNG:</b> • Wand mit Unterst�tzung und Kleber	<b>APLICACIONES:</b> • Pared con soporte y pegamento
<b>DIMENSIONI:</b> • <b>Surface</b> L 100 x H 270   300 cm L 39.8 x H 106.3   118.1 in • <b>Product</b> L 101 x H 104   Ø 101 cm L 39.8 x H 39.8   Ø 39.8 in <i>Le dimensioni, il design e i tagli sono personalizzabili su misura</i>	<b>DIMENSIONS:</b> • <b>Surface</b> L 100 x H 270   300 cm L 39.8 x H 106.3   118.1 in • <b>Product</b> L 101 x H 104   Ø 101 cm L 39.8 x H 39.8   Ø 39.8 in <i>The dimensions, the design and the cuts can be customized to measure.</i>	<b>DIMENSIONS:</b> • <b>Surface</b> L 100 x H 270   300 cm L 39.8 x H 106.3   118.1 in • <b>Product</b> L 101 x H 104   Ø 101 cm L 39.8 x H 39.8   Ø 39.8 in <i>Les dimensions, le design et les coupes sont personnalisables sur mesure</i>	<b>DIMENSION:</b> • <b>Surface</b> L 100 x H 270   300 cm L 39.8 x H 106.3   118.1 in • <b>Product</b> L 101 x H 104   Ø 101 cm L 39.8 x H 39.8   Ø 39.8 in <i>Abmessungen, Design und Schnitte k�nnen nach Ma� angepasst werden</i>	<b>DIMENSIONES:</b> • <b>Surface</b> L 100 x H 270   300 cm L 39.8 x H 106.3   118.1 in • <b>Product</b> L 101 x H 104   Ø 101 cm L 39.8 x H 39.8   Ø 39.8 in <i>Las dimensiones, el dise�o y los cortes son personalizables para medir</i>
<b>SPESSORE:</b> 8,5 cm 3.35 in	<b>THICKNESS:</b> 8,5 cm 3.35 in	<b>�PAISSEUR:</b> 8,5 cm 3.35 in	<b>DICKE:</b> 8,5 cm 3.35 in	<b>GRUESO:</b> 8,5 cm 3.35 in
<b>PESO:</b> 3420 gr/mtl 2.28 lb/ft	<b>WEIGHT:</b> 3420 gr/mtl 2.28 lb/ft	<b>POIDS:</b> 3420 gr/mtl 2.28 lb/ft	<b>GEWICHT:</b> 3420 gr/mtl 2.28 lb/ft	<b>PESO:</b> 3420 gr/mtl 2.28 lb/ft
<b>COMPOSIZIONE:</b> • <b>PETfelt</b> - 100% PET	<b>COMPOSITION:</b> • <b>PETfelt</b> - 100% PET	<b>COMPOSITION:</b> • <b>PETfelt</b> - 100% PET	<b>ZUSAMMENSETZUNG:</b> • <b>PETfelt</b> - 100% PET	<b>COMPOSICI�N:</b> • <b>PETfelt</b> - 100% PET
<b>DIFFERENZE DI COLORE:</b> Leggere differenze di colore fra una partita e l'altra sono da considerarsi normali	<b>COLOR DIFFERENCES:</b> Slight differences between dyeing lots are considered normal	<b>DIFF�RENCES DE COULEUR:</b> Les diff�rences de couleurs claires entre un jeu et un autre sont consid�r�es comme normales	<b>FARBUNTERSCHIEDE:</b> Helle Farbunterschiede zwischen einem Spiel und einem anderen werden als normal angesehen	<b>DIFERENCIAS DE COLOR:</b> Las diferencias de color de luz entre un juego y otro se consideran normales
<b>RICICLABILIT�:</b> Materiale realizzato dal riciclo di bottiglie di plastica, riciclabile nel rispetto dell'ambiente	<b>RECYCLABILITY:</b> Material made from recycled plastic bottles, recyclable product respecting the environment	<b>RECYCLAGE:</b> Mat�riau fabriqu� du recyclage des bouteilles en plastique, recyclable dans le respect de l'environnement	<b>RECYCLINGF�HIGKEIT:</b> Material aus dem Recycling von Plastikflaschen, recycelbar in Bezug auf die Umwelt	<b>RECICLABILIDAD:</b> Material elaborado a partir del reciclado de botellas, reciclable con respecto al medio ambiente
<b>MANUTENZIONE:</b> Usare con regolarit� l'aspirapolvere a beccuccio liscio, oppure utilizzare spazzole a setole morbide o detersivi professionali per imbottiti	<b>MAINTENANCE:</b> Regularly and carefully use the vacuum cleaner with a smooth spout or use soft bristle brushes or professional pads for padding and upholstery	<b>ENTRETIEN:</b> Utilisez r�guli�rement l'aspirateur avec un bec lisse ou utilisez des brosses � poils doux ou des patins professionnels pour le rembourrage	<b>INSTANDHALTUNG:</b> Verwenden Sie regelm��ig den glatten Staubsauger, oder verwenden Sie weiche Borstenpinsel oder professionelle gepolsterte Reiniger	<b>MANTENIMIENTO:</b> Use la aspiradora de pico liso regularmente, o use cepillos de cerdas suaves o limpiadores acolchados profesionales
				
<b>REAZIONE AL FUOCO:</b> B-s2, d0 - <i>OPZIONALE</i>	<b>FIRE REACTION:</b> B-s2, d0 - <i>OPTIONAL</i>	<b>R�ACTION AU FEU:</b> B-s2, d0 - <i>EN OPTION</i>	<b>Brandverhalten - Klasse:</b> B-s2, d0 - <i>OPTIONAL</i>	<b>REACCI�N AL FUEGO:</b> B-s2, d0 - <i>OPTIONAL</i>
<b>MARCATURA CE:</b> B-s1, d0 - <i>OPZIONALE</i>	<b>CE MARK:</b> B-s1, d0 - <i>OPTIONAL</i>	<b>CE MARQ:</b> B-s1, d0 - <i>EN OPTION</i>	<b>KENNZEICHNUNG CE:</b> B-s1, d0 - <i>OPTIONAL</i>	<b>MARCADO CE:</b> B-s1, d0 - <i>OPTIONAL</i>
<b>FONO ASSORBIMENTO:</b> UNI EN ISO 354: 2003 UNI EN ISO 11654: 1998	<b>SOUND ABSORPTION:</b> UNI EN ISO 354: 2003 UNI EN ISO 11654: 1998	<b>ABSORPTION DU SON:</b> UNI EN ISO 354: 2003 UNI EN ISO 11654: 1998	<b>SCHALLABSORPTION:</b> UNI EN ISO 354: 2003 UNI EN ISO 11654: 1998	<b>ABSORCI�N DE SONIDO:</b> UNI EN ISO 354: 2003 UNI EN ISO 11654: 1998

## HARDfelt:



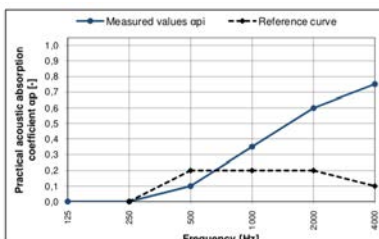
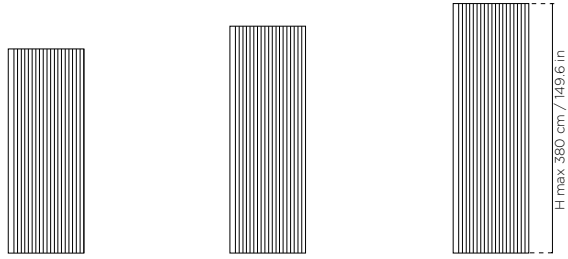
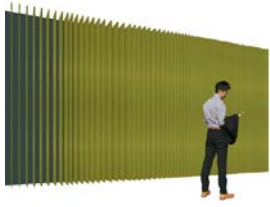

velcro adesivo incluso  
selfadhesive velcro included  
bande Velcro inclus  
Klettband enthalten  
cinta de velcro incluidas

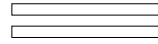

COD	LM-100.270/V	LM-100.300/V	LM/V-CUSTOM
CM	100xH270x8,5	100xH300x8,5	
IN	39.37xH106.30x3.35	39.37xH118.11x3.35	
CO	CAT A	CAT A	CAT A
€	ON REQUEST	ON REQUEST	ON REQUEST

Front: CAT A/B

Back: Black

Plan view:

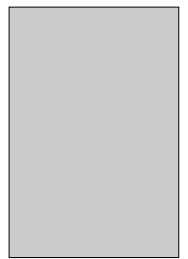
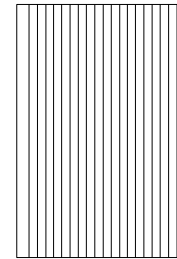
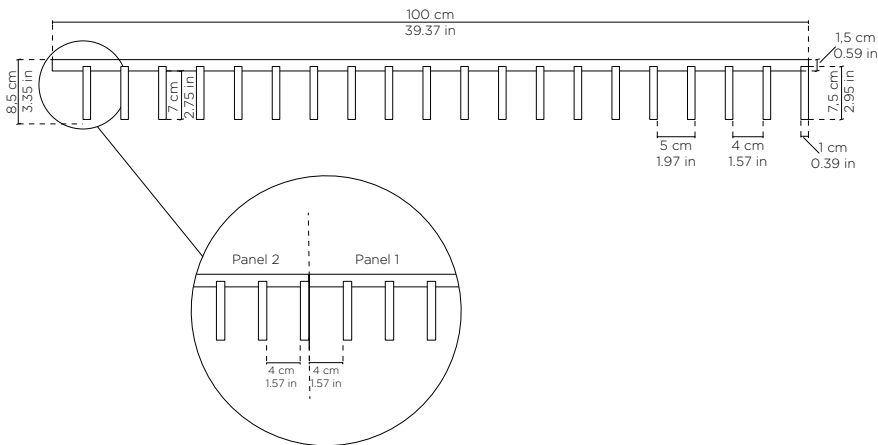

Axonomic view:

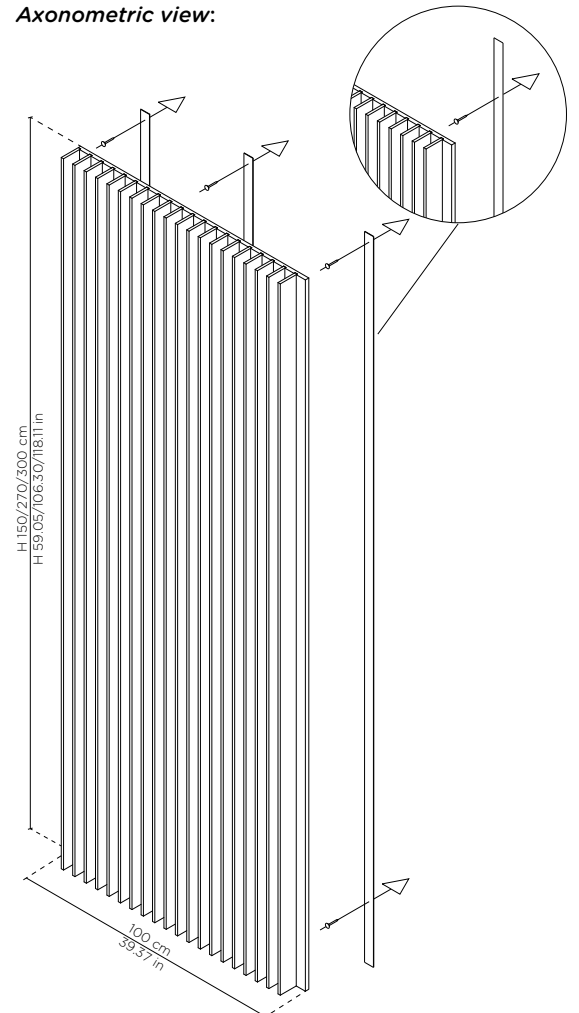

Personalizza il tuo spazio!

Customize your space!

disponibili ulteriori forme, dimensioni e spessori su richiesta  
further shapes, sizes and thickness available on request  
autres formes, tailles et épaisseurs disponibles sur demande  
Andere Formen, Größen und Dicken auf Anfrage erhältlich  
otras formas, tamaños y grosos disponibles bajo pedido

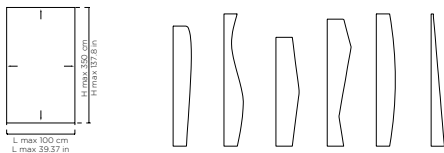

EH! ASPETTA! HEY WAIT!

Sopra e sotto il pannello non è rivestito!  
Aggiungi la LAMELLA di chiusura!

Above and below the panel is not coated! Add the closing LAMELLA!  
Au-dessus et au-dessous du panneau n'est pas enduit! Ajoutez la fermeture LAMELLA!  
Oben und unten ist die Platte nicht beschichtet! Fügen Sie die schließende LAMELLE hinzu!  
Por encima y por debajo el panel no está revestido! Agregue la LAMELLA de cierre!

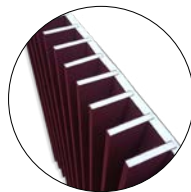
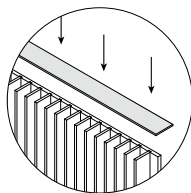

ATTENZIONE! BE CAREFUL!

Costi di spedizione vedi pag. 3  
For shipping prices see p.3





COD	<b>LM-S-101.101</b>	<b>LM-C-101</b>
CM	101xH101x8,5	Ø101x8,5
IN	39.76xH39.76x3.35	Ø39.76x3.35
CO	CAT A	CAT A
€		



velcro adesivo incluso  
selfadhesive velcro included  
bande Velcro inclus  
Klettband enthalten  
cinta de velcro incluidas

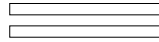

Front: CAT A/B

Back: Black

Plan view Lamellae Round:

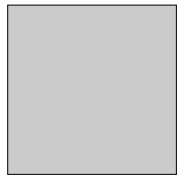
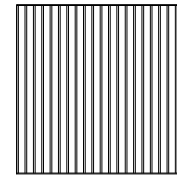
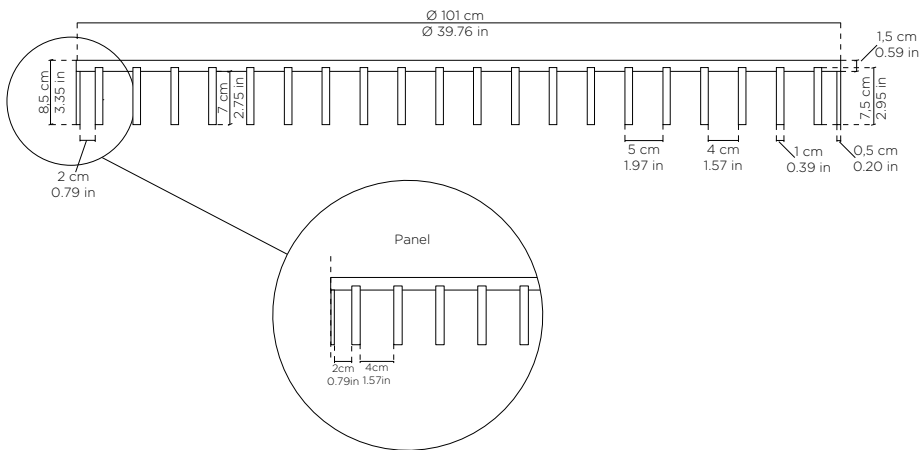

Plan view Lamellae Square:

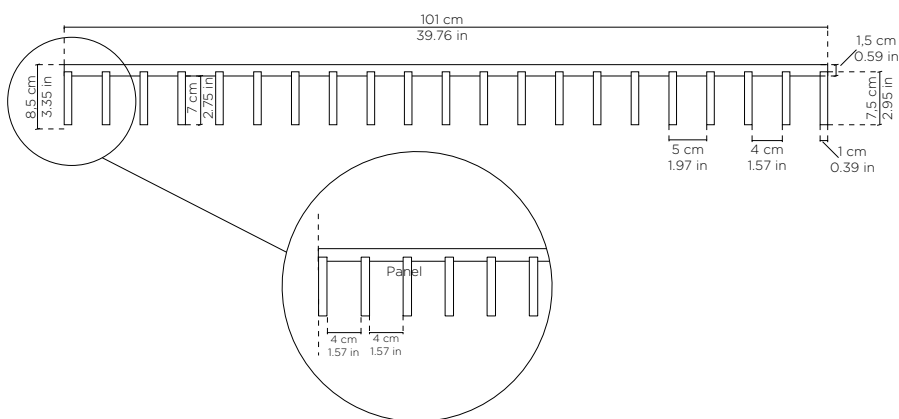

Axonomic view:

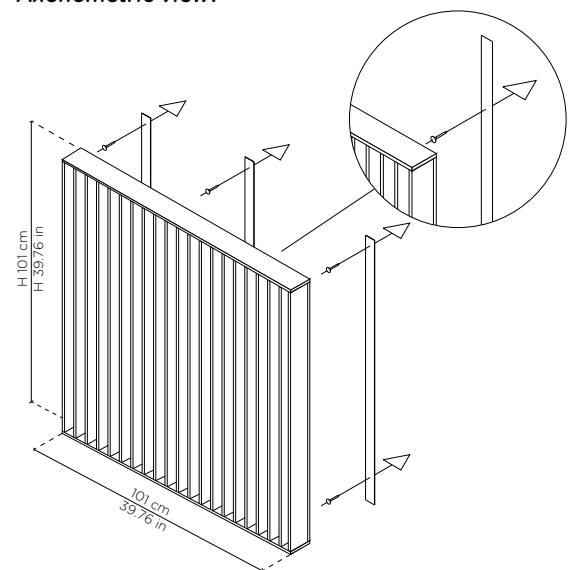

Personalizza il tuo spazio!

Customize your space!

disponibili ulteriori forme, dimensioni e spessori su richiesta  
further shapes, sizes and thickness available on request  
autres formes, tailles et épaisseurs disponibles sur demande  
Andere Formen, Größen und Dicken auf Anfrage erhältlich  
otras formas, tamaños y grosores disponibles bajo pedido

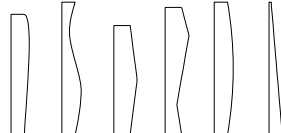
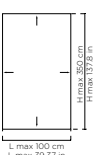

LO SAPEVI? DID YOU KNOW THAT?

Sopra e sotto il pannello è rivestito!  
Above and below the panel is already coated!  
Au-dessus et au-dessous, le panneau est déjà enduit!  
Oben und unten ist das Panel bereits beschichtet!  
Por encima y por debajo el panel ya está revestido!

