

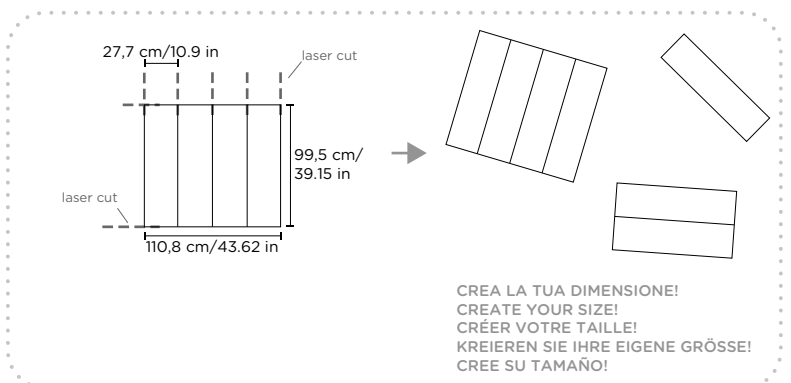

ECOSTRONG

IT	EN	FR	DE	ES
NOME: ECostrong	NAME: ECostrong	DENOMINATION: ECostrong	NAME: ECostrong	NOMBRE: ECostrong
DESCRIZIONE: Pannello monomaterico fonoaassorbente termoformato	DESCRIPTION: Single-material sound absorbing panel thermoformed	DESCRIPTION: Panneau absorbant acoustique thermoformé	BESCHREIBUNG: Thermogeformte Schallschutzplatte aus Monomaterial	DESCRIPCIÓN: Panel monomaterico acústico termoformado
APPLICAZIONI: • Muro con velcro, calamite o ventose • Scrivania con staffe • Soffitto con velcro o calamite • Soffitto pendinato • Baffle con calamite o cavetti • Autoportante, totem con staffe	APPLICAZIONI: • Wall with velcro, magnets or suckers • Desk with brackets • Panels with velcro or magnets • Suspended ceiling • Baffles with magnets or cables • Freestanding, totem with brackets	APPLICATION: • Mur avec velcro, aimants ou ventouses • Bureau avec supports • Plafond avec velcro ou aimants • Plafond suspendu • Baffles avec aimants ou câbles • Autoportant, totem avec supports	ANWENDUNG: • Wand: Klettverschluss, Magneten, Saugnapfen • Schreibtisch: Klammern • Decke: Klettverschluss, Magneten • Abgehängte Decke • Baffeln: Magneten, Kabeln • Selbsttragend, Totem: Klammern	APLICACIONES: • Pared con velcro, imanes o ventosas • Escritorio con soportes • Techo con velcro o imanes • Techo suspendido • Deflectores con imanes o cables • Tótem, autoportante con soportes
DIMENSIONI: 27,7 55,4 110,8 x 99,5 x SP 2,3 4 cm 10,9 21,81 43,62 x 39,17 x SP 0,9 1,58 in <i>I pannelli potranno avere differenze di spessore dovute alla tipologia del materiale</i>	DIMENSIONS: 27,7 55,4 110,8 x 99,5 x THK 2,3 4 cm 10,9 21,81 43,62 x 39,17 x THK 0,9 1,58 in <i>Panels may have differences in thickness due to the type of material</i>	DIMENSIONS: 27,7 55,4 110,8 x 99,5 x ÉPAIS 2,3 4 cm 10,9 21,81 43,62 x 39,17 x ÉPAIS 0,9 1,58 in <i>Les panneaux peuvent avoir des différences d'épaisseur dues à la typologie du matériau</i>	DIMENSION: 27,7 55,4 110,8 x 99,5 x D 2,3 4 cm 10,9 21,81 43,62 x 39,17 x D 0,9 1,58 in <i>Platten können aufgrund der Material Typologie Dickenunterschiede aufweisen</i>	DIMENSIONES: 27,7 55,4 110,8 x 99,5 x ESP 0,9 1,58 in 10,9 21,81 43,62 x 39,17 x ESP 0,9 1,58 in <i>Los paneles pueden tener diferencias de grosor debido a la tipología del material</i>
PESO: 2,9 kg/m ² - 0.59 lb/ft ²	WEIGHT: 2,9 kg/m ² - 0.59 lb/ft ²	POIDS: 2,9 kg/m ² - 0.59 lb/ft ²	GEWICHT: 2,9 kg/m ² - 0.59 lb/ft ²	PESO: 2,9 kg/m ² - 0.59 lb/ft ²
COMPOSIZIONE: • Anima: Materiale fonoaassorbente composto da materiale riciclato, 100% fibre in poliestere Reazione al fuoco: CL1 Classe fumo: F1 Certificato: Oekotex	COMPOSITION: • Soul: Sound absorbing material made of 100% recycled material, of polyester fibers Reaction to fire: CL1 Smoke class: F1 Certificate: Oekotex	COMPOSITION: • Âme: Matériau absorbant acoustique composé de fibres discontinues 100% polyester Réaction au feu: CL1 Réaction à la fumée: F1 Certificat: Oekotex	ZUSAMMENSETZUNG: • Innere: 100% recyceltes schallschluckendes Material, aus Polyesterfaser. Brandverhalten: CL1 Rauchklasse: F1 Bescheinigung: Oekotex	COMPOSICIÓN: • Alma: material acústico compuesto de material 100% reciclado, fibra de poliéster Reacción al fuego: CL1 Clase de fumo: F1 Certificado: Oekotex
FINITURE: • CAT A - Trevira CS, ECOfelt, PETfelt, PETfabric, PETcolor, Velvet • CAT B - Tweed, Trace	FINISHING: • CAT A - Trevira CS, ECOfelt, PETfelt, PETfabric, PETcolor, Velvet • CAT B - Tweed, Trace	REVÊTEMENT: • CAT A - Trevira CS, ECOfelt, PETfelt, PETfabric, PETcolor, Velvet • CAT B - Tweed, Trace	FINISH: • CAT A - Trevira CS, ECOfelt, PETfelt, PETfabric, PETcolor, Velvet • CAT B - Tweed, Trace	ACABADO DEL PANEL: • CAT A - Trevira CS, ECOfelt, PETfelt, PETfabric, PETcolor, Velvet • CAT B - Tweed, Trace
RICICLABILITÀ: Pannello di materiale riciclato e riciclabile alla fine della sua vita, senza separare anima e finitura	RECYCLABILITY: Recycled material panel recyclable at the end of his life, without dividing soul and finish	RECYCLAGE: Panneau recyclé et recyclable en fin de vie, sans séparer les composants	RECYCLINGFÄHIGKEIT: Das Paneel besteht aus recyceltem Material und es kann wieder recycelt sein am Ende seines Leben	RECICLABILIDAD: Panel de material reciclado y reciclable al final de su vida, sin tener que separar el alma y el forro.
MANUTENZIONE: Pannello pulibile con detergenti specifici	MAINTENANCE: Cleanable panel with specific detergents	ENTRETIEN: Le panneau peut être nettoyé avec des détergents adaptés	INSTANDHALTUNG: Man kann das Paneel mit spezifischer Reinigungsmitteln säubern	MANTENIMIENTO: Panel limpiable con detergentes específicos.
REAZIONE AL FUOCO: B-s2, d0	FIRE REACTION: B-s2, d0	RÉACTION AU FEU: B-s2, d0	Brandverhalten - Klasse: B-s2, d0	REACCIÓN AL FUEGO: B-s2, d0
MARCATURA CE: B-s1, d0	CE MARK: B-s1, d0	CE MARQ: B-s1, d0	KENNZEICHNUNG CE: B-s1, d0	MARCADO CE: B-s1, d0
CERTIFICAZIONI ECOLOGICHE: GREENGUARD GREENGUARD GOLD	GREEN LABELS: GREENGUARD GREENGUARD GOLD	ÉTIQUETTES ÉCOLOGIQUE: GREENGUARD GREENGUARD GOLD	ÖKOLOGISCHE ZERTIFIZIERUNG: GREENGUARD GREENGUARDGOLD	CERTIFICACIONES ECOLÓGICAS: GREENGUARD GREENGUARDGOLD
FONO ASSORBIMENTO: UNI EN ISO 354: 2003 UNI EN ISO 11654: 1998	SOUND ABSORPTION: UNI EN ISO 354: 2003 UNI EN ISO 11654: 1998	ABSORPTION DU SON: UNI EN ISO 354: 2003 UNI EN ISO 11654: 1998	SCHALLABSORPTION: UNI EN ISO 354: 2003 UNI EN ISO 11654: 1998	ABSORCIÓN DE SONIDO: UNI EN ISO 354: 2003 UNI EN ISO 11654: 1998

$$\alpha_w = 0,85 \quad | \quad NRC = 0,79$$

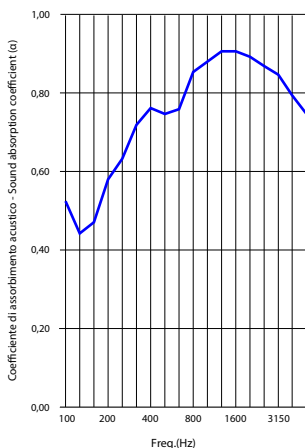

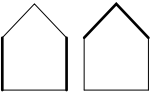

Section:

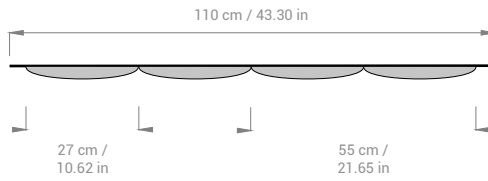

pannello monofacciale | single-sided panel |
panneau à simple face | Einseitige Paneel |
panel mono-facial



COD	ESWC-M-100.27/V
CM	27xH99x2,3
IN	10.6xH39x0.9
CO	CAT A
€	
CO	CAT B
€	



COD	ESWC-M-100.55/V
CM	55xH99x2,3
IN	21.7xH39x0.9
CO	CAT A
€	
CO	CAT B
€	



velcro adesivo incluso
selfadhesive velcro included
bande Velcro inclus
Klettband enthalten
cinta de velcro incluidas

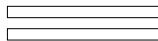

COD	ESWC-M-100.110/V
CM	110xH99x2,3
IN	43.3xH39x0.9
CO	CAT A
€	
CO	CAT B
€	

MONO:

Front: CAT A/B

Back: Black

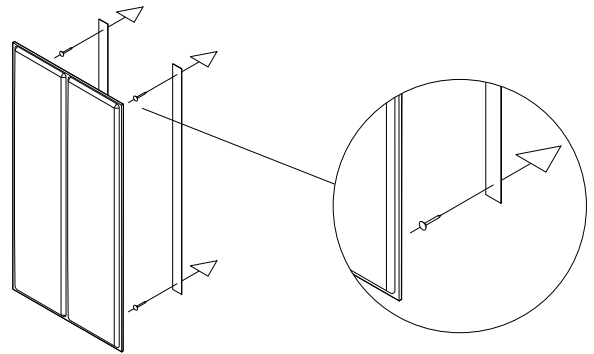

Ideali se vuoi affiancare i pannelli:

Ideal if you want to place panels side by side:

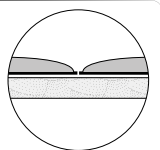

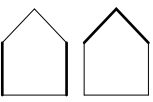

Section:

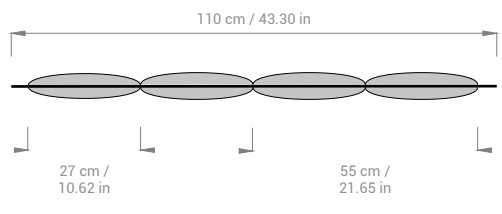



pannello bifacciale | double-sided panel |
panneau à double face | Doppelseitige Paneel |
panel bi-facial

BI: **Front: CAT A/B** **Back: CAT A/B**

calamita + disco distanziale + calamita + disco
magnet + disk spacer + magnet + disk
aimant + disque espaceur + aimant + disque
Magnet + Scheibe Abstandshalter + Magnet + Scheibe
imán + disco espaciador + imán + disco

COD ESWC-100.55
CM 55xH99x4
IN 21.7xH39x1.58
CO CAT A
€
CO CAT B
€



	
MN-2-D	DISN-2-M-D
	5
	2
CR	CR

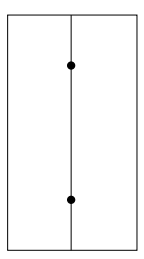
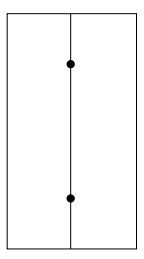



COD ESWC-100.110
CM 110xH99x4
IN 43.3xH39x1.58
CO CAT A
€
CO CAT B
€

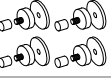
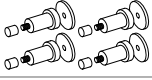

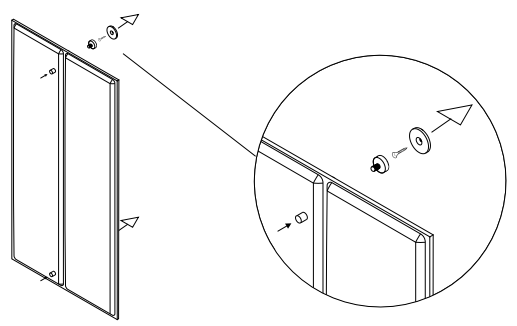
	
MN-4-D	DISN-4-M-D
	5
	2
CR	CR

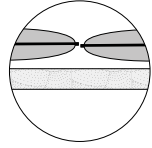

Non ideali se vuoi affiancare i pannelli:
Not ideal if you want to place panels side by side:



Scegli i pannelli monofacciali! vedi pag.
Chose the single-sided panel see p.



foro singolo + cavo regolabile
single hole + adjustable cable
seul trou + câble réglable
einzelnes Loch + verstellbares Kabel
solo agujero + cable ajustable

doppio foro + cavo regolabile
double hole + adjustable cable
trou double + câble réglable
Doppelloch + verstellbares Kabel
doble agujero + cable ajustable

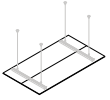

COD	EST-100.55
CM	55x99x4
IN	21.7x39x1.58
CO	CAT A
€	
CO	CAT B
€	

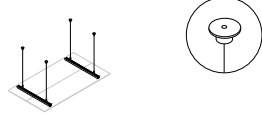

BIN1P-S-F
L32 cm - 3ml
L12.6 in - 3.28 yd
Bi

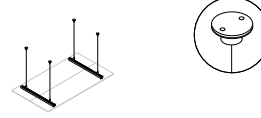

BIN1P-S-F2
L32 cm - 3ml
L12.6 in - 3.28 yd
Bi

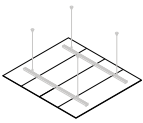

COD	EST-100.110
CM	110x99x4
IN	43.3x39x1.58
CO	CAT A
€	
CO	CAT B
€	

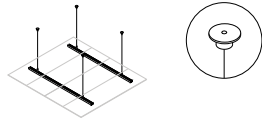

BIN2P-S-F
L87 cm - 3ml
L34.25 in - 3.28 yd
Bi

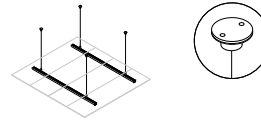

BIN2P-S-F2
L87 cm - 3ml
L34.25 in - 3.28 yd
Bi

Axonometric view:

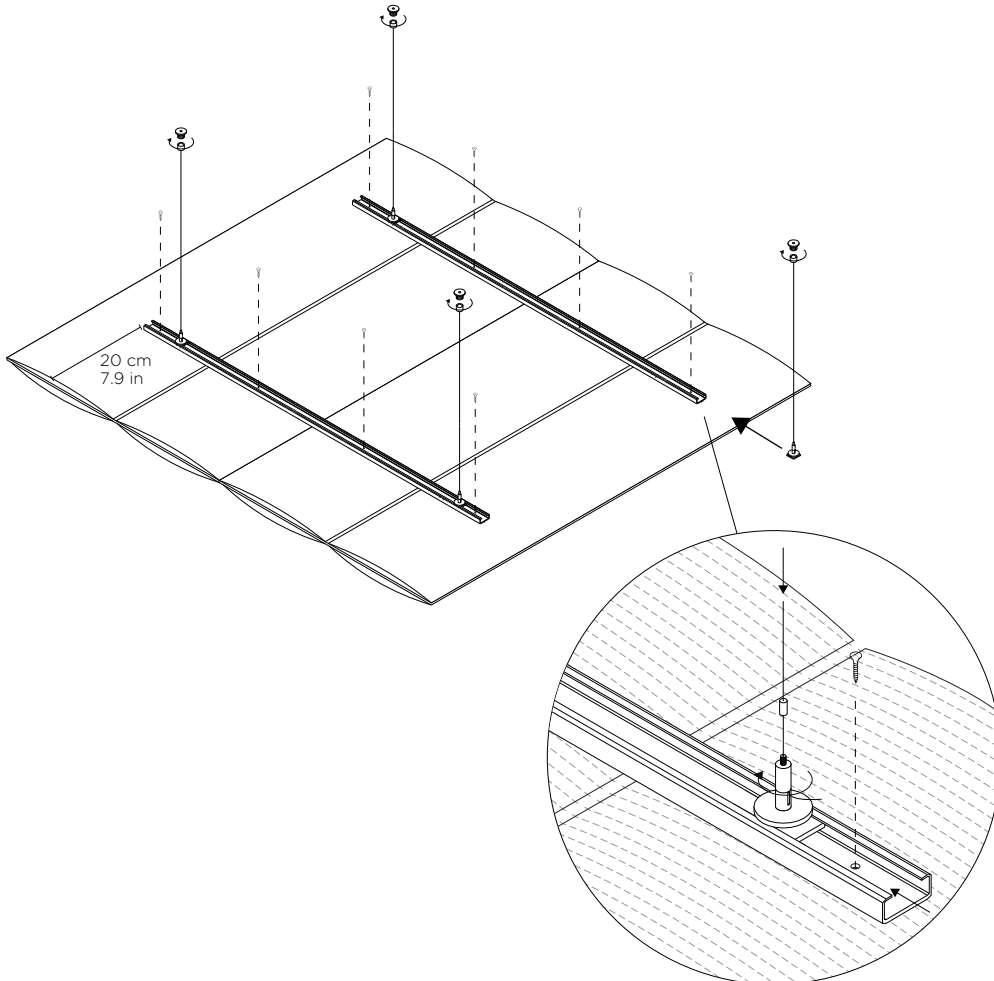

Plan view:

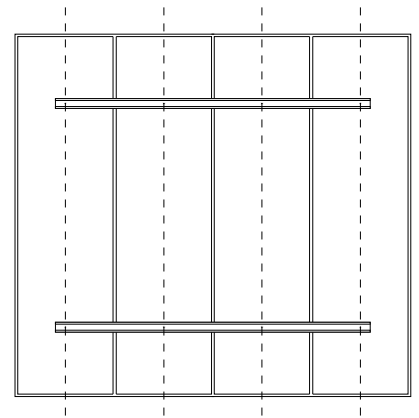



foro singolo + cavo regolabile
single hole + adjustable cable
seul trou + câble réglable
einzelnes Loch + verstellbares Kabel
solo agujero + cable ajustable

doppio foro + cavo regolabile
double hole + adjustable cable
trou double + câble réglable
Doppelloch + verstellbares Kabel
doble agujero + cable ajustable

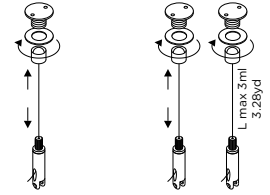
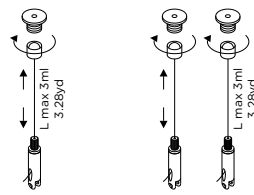

CM-1-F	CM-2-F
3ml	3ml
3.28yd	3.28yd
CR	CR

CM-1-F2	CM-2-F2
3ml	3ml
3.28yd	3.28yd
CR	CR

calamita + disco + cavo regolabile
magnet + disk + adjustable cable
aimant + disque + câble réglable
Magnet + Scheibe + verstellbares Kabel
imán + disco + cable ajustable

calamita + disco
magnet + disk
aimant + disque
Magnet + Scheibe
imán + disco

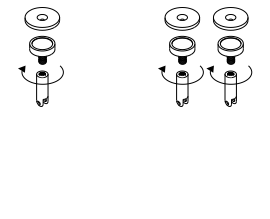
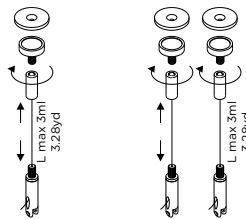

CM-1-M	CM-2-M
3ml	3ml
3.28yd	3.28yd
CR	CR

DIS-1-M	DIS-2-M
Ø2x4,5	Ø2x4,5
Ø0.8x1.8	Ø0.8x1.8
CR	CR

ganci percontrosoffitto
false ceiling hooks
crochets de faux-plafond
abgehangte Decken-Haken
ganchos de techo falso

cavo + gancio controsoffitto
cable + false ceiling hook
câble + crochet faux-plafond
Kabel + abgehangte Decken-Haken
cable + gancho de techo falso

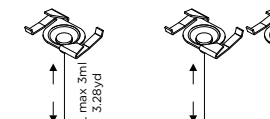
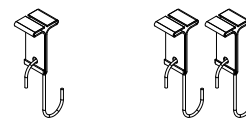

GS-1-GM	GS-2-GM
2,6x2xH9,4	2,6x2xH9,4
1x0.8xH3.7	1x0.8xH3.7
CR	CR

CM-1-G	CM-2-G
3ml	3ml
3.28yd	3.28yd
CR	CR

COD	ESB-100.27	ESB-27.100	ESB-100.55	ESB-100.110	ESB-110.100
CM	99xH27x4	27xH99x4	99xH55x4	99xH110x4	110xH99x4
IN	39xH10.6x1.58	10.6xH139x1.58	39xH21.7x1.58	39xH43.3x1.58	43.3xH39x1.58
CO	CAT A	CAT A	CAT A	CAT A	CAT A
€					
CO	CAT B	CAT B	CAT B	CAT B	CAT B
€					

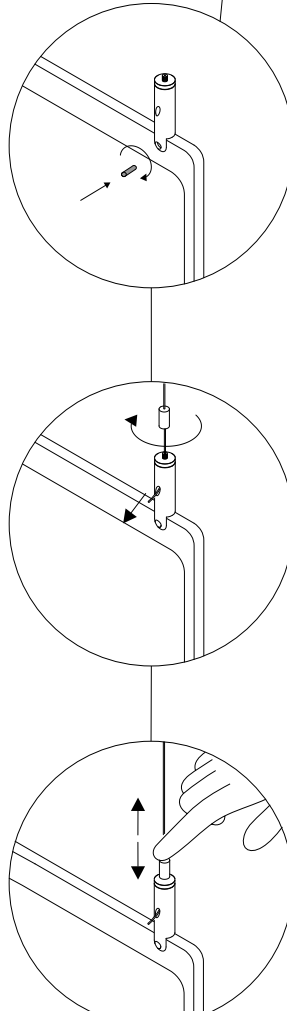



H 126 cm
H 49.6 in

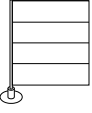

COD	SL10ES2
CO	CAT A
€	
CO	CAT B
€	

Ø25
Ø9.8

COD	SL10ES2/32
CO	CAT A
€	
CO	CAT B
€	

Ø32
Ø12.6

H55/
H21.7
H55/
H21.7

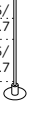

SL-M12/5
AG



SL-M/M12/5
AG

SL-M12/5/32
AG

SL-M/M12/5/32
AG

H 153 cm
H 60.2 in

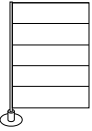

COD	SL10ES2/1
CO	CAT A
€	
CO	CAT B
€	

Ø25
Ø9.8

COD	SL10ES2/1/32
CO	CAT A
€	
CO	CAT B
€	

Ø32
Ø12.6

H27*
H55/
H21.7
H55/
H21.7

*H10.6



SL-M16/5
AG



SL-M/M16/5
AG

SL-M16/5/32
AG

SL-M/M16/5/32
AG

H 181 cm
H 71.3 in



COD	SL10ES3
CO	CAT A
€	
CO	CAT B
€	

Ø25
Ø9.8

COD	SL10ES3/32
CO	CAT A
€	
CO	CAT B
€	

Ø32
Ø12.6

H55/
H21.7
H55/
H21.7
H55/
H21.7

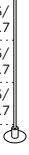

SL-M18/5
AG



SL-M/M18/5
AG

SL-M18/5/32
AG

SL-M/M18/5/32
AG

H 209 cm
H 82.3 in



COD	SL10ES3/1
CO	CAT A
€	
CO	CAT B
€	

Ø25
Ø9.8

COD	SL10ES3/1/32
CO	CAT A
€	
CO	CAT B
€	

Ø32
Ø12.6

H27*
H55/
H21.7
H55/
H21.7
H55/
H21.7

*H10.6

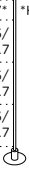

SL-M22/5
AG



SL-M/M22/5
AG

SL-M22/5/32
AG

SL-M/M22/5/32
AG

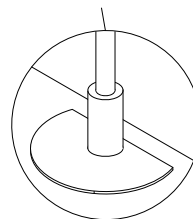
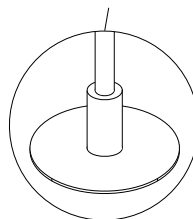



EHI ASPETTA! HEY WAIT!

*Non dimenticarti il montante finale!
Don't forget the final riser!
N'oubliez pas la contremarche finale!
Vergiss den letzten Riser nicht!
No te olvides de la contrahuella final!*

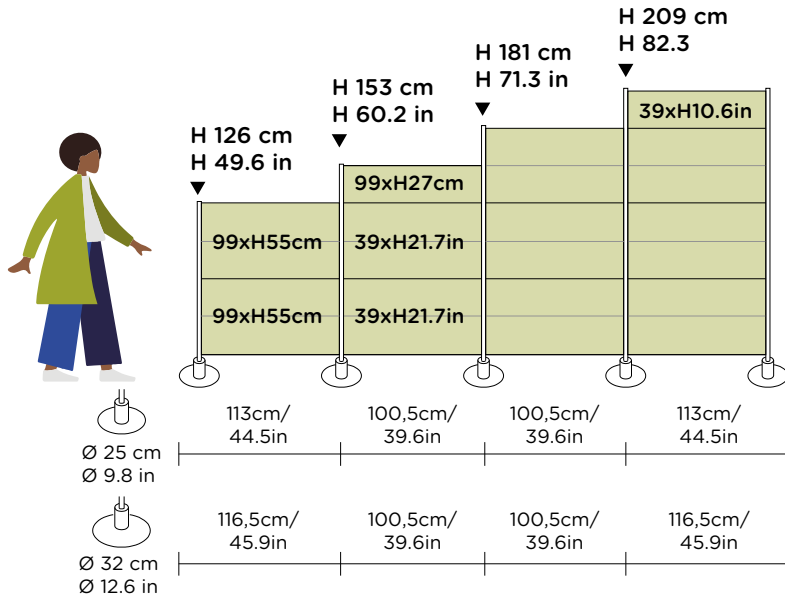



Panels:

		
COD	SL10/2ES	SL10ES
CM	99xH27x4	99xH55x4
IN	39xH10.6x1.58	39xH21.7x1.58
CO	CAT A	CAT A
€		
CO	CAT B	CAT B
€ TW		

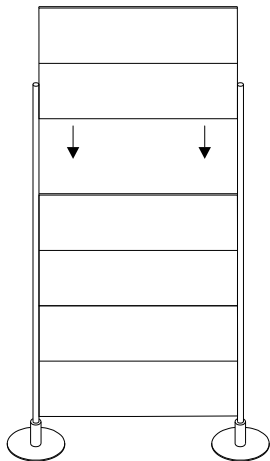

Ti piacciono i colori? Do you like colors?

I montanti nei colori fuori serie **NERO** (NG) e **BIANCO** (BO), sono soggetti ad un aumento del +15% sul prezzo di listino.

I montanti nei colori **RAL** sono disponibili su richiesta.

Special upright colors **BLACK** (NG) and **WHITE** (BO), undergo an increase of +15% on the pricelist.

The uprights in the **RAL** colours are available on request.

Les montants en couleurs **NOIR** (NG) et **BLANC** (BO), sont soumis à une augmentation de +15% sur le prix de liste.

Les montants dans les couleurs **RAL** sont disponibles sur demande.

Farbe **SCHWARZ** (NG) und **WEISS** (BO), verfügbar mit +15% auf Preisliste.

Die Ständer in den **RAL**-Farben sind auf Anfrage erhältlich.

Colores por montantes **NEGRO** (NG) y **BLANCO** (BO), están sujetos a un incremento del +15% su precio de lista.

Los montantes en los colores **RAL** están disponibles a petición.

Possiamo esserti d'aiuto? Guarda l'esempio:
Can we help you? Look at the exemple:

Example:

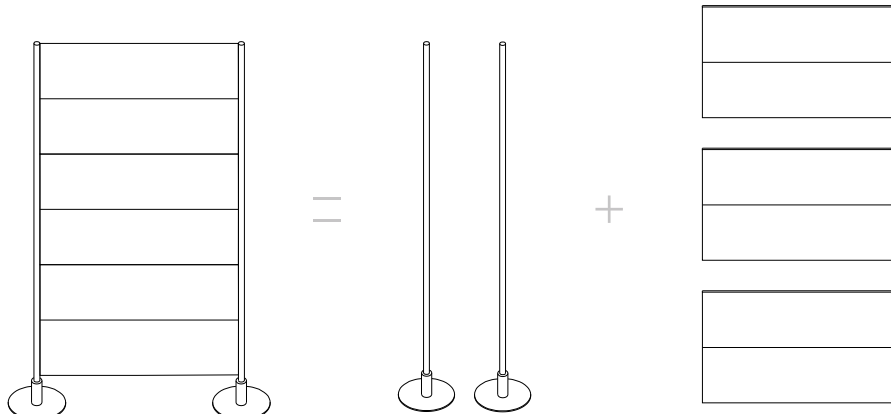



COD	EST-100.55
CM	55xH99x4
IN	21.7xH39x1.58
CO	CAT A
€	
CO	CAT B
€	

H 95 cm
H 37.4 in



ED-SAT-9
Ø25xH95
Ø9.8xH37.4
Bo - GR - NE

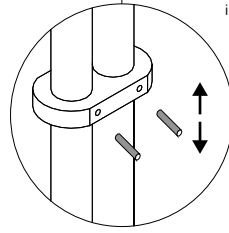
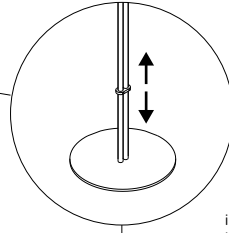

incluso
included
inclus
enthalten
incluidas

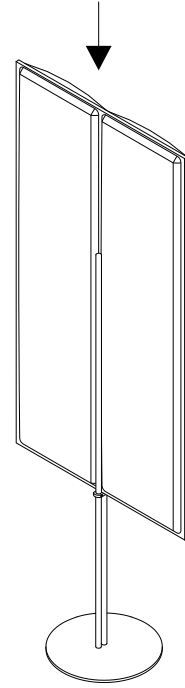

Ti piacciono i colori? Do you like colors?

I montanti nei colori fuori serie **NERO** (NG) e **BIANCO** (BO), sono soggetti ad un aumento del +15% sul prezzo di listino.

I montanti nei colori **RAL** sono disponibili su richiesta.

Special upright colors **BLACK** (NG) and **WHITE** (BO), undergo an increase of +15% on the pricelist.

The uprights in the **RAL** colours are available on request.

Les montants en couleurs **NOIR** (NG) et **BLANC** (BO), sont soumis à une augmentation de +15% sur le prix de liste.

Les montants dans les couleurs **RAL** sont disponibles sur demande.

Farbe **SCHWARZ** (NG) und **WEISS** (BO), verfügbar mit +15% auf Preisliste.

Die Ständer in den **RAL**-Farben sind auf Anfrage erhältlich.

Colores por montantes **NEGRO** (NG) y **BLANCO** (BO), están sujetos a un incremento del +15% su precio de lista.

Los montantes en los colores **RAL** están disponibles a petición.

