























ECOBOOTH

ECORANGE

IT	EN	FR	DE	ES
NOME: ECObooth	NAME: ECObooth	DENOMINATION: ECObooth	NAME: ECObooth	NOMBRE: ECObooth
DESCRIZIONE: Cabina fonoassorbente termoformata a incastri	DESCRIPTION: Sound-absorbing interlocking thermoformed cabin	DESCRIPTION: Cabines acoustique thermoformée avec joints	BESCHREIBUNG: Schalldämmende Verriegelung tiefgezogene Kabine	DESCRIPCIÓN: Panel monomaterico acústico termoformado
APPLICAZIONI: • Scrivania • Parete con struttura	APPLICAZIONI: • Desk • Wall with structure	APPLICATION: • Bureau • Mur avec structure	ANWENDUNG: • Schreibtisch • Wand mit Struktur	APLICACIONES: • Escritorio • Pared con estructura
DIMENSIONI: 60,4 x 69,6 x H 71,5 cm 23,8 x 27,4 x H 28,2 in <i>I pannelli potranno avere differenze di spessore dovute alla tipologia del materiale</i>	DIMENSIONS: 60,4 x 69,6 x H 71,5 cm 23,8 x 27,4 x H 28,2 in <i>Panels may have differences in thickness due to the type of material</i>	DIMENSIONS: 60,4 x 69,6 x H 71,5 cm 23,8 x 27,4 x H 28,2 in <i>Les panneaux peuvent avoir des différences d'épaisseur dues à la typologie du matériau</i>	DIMENSION: 60,4 x 69,6 x H 71,5 cm 23,8 x 27,4 x H 28,2 in <i>Platten können aufgrund der Material Typologie Dickenunterschiede aufweisen</i>	DIMENSIONES: 60,4 x 69,6 x H 71,5 cm 23,8 x 27,4 x H 28,2 in <i>Los paneles pueden tener diferencias de grosor debido a la tipología del material</i>
PESO: 4,8 kg 10,58 lb	WEIGHT: 4,8 kg 10,58 lb	POIDS: 4,8 kg 10,58 lb	GEWICHT: 4,8 kg 10,58 lb	PESO: 4,8 kg 10,58 lb
COMPOSIZIONE: • Anima: Materiale fonoassorbente composto da materiale riciclato, 100% fibre in poliestere Reazione al fuoco: CL1 Classe fumo: F1 Certificato: Oekotex	COMPOSITION: • Soul: Sound absorbing material made of 100% recycled material, of polyester fibers Reaction to fire: CL1 Smoke class: F1 Certificato: Oekotex	COMPOSITION: • Âme: Matériau absorbant acoustique composé de fibres discontinues 100% polyester Réaction au feu: CL1 Réaction à la fumée: F1 Certificat: Oekotex	ZUSAMMENSETZUNG: • Innere: 100% recyceltes schallschluckendes Material, aus Polyesterfasern Brandverhalten: CL1 Rauchklasse: F1 Bescheinigung : Oekotex	COMPOSICIÓN: • Alma: material acústico compuesto de material 100% reciclado, fibra de poliéster Reacción al fuego: CL1 Clase de fumo: F1 Certificado: Oekotex
FINITURE: • Trevira CS - 100% poliestere Reazione al fuoco: CL1 Certificato: Oekotex • ECOfelt - 90% lana, 10% poliestere	FINISHING: • Trevira CS - 100% polyester Reaction to fire: CL1 Certificate: Oekotex • ECOfelt - 90% wool, 10% polyester	REVÊTEMENT: • Trevira CS - 100% polyester Réaction au feu: CL1 Certificat: Oekotex • ECOfelt - 90% laine, 10% polyester	FINISH: • Trevira CS - 100% Polyester Brandverhalten: CL1 Bescheinigung: Oekotex • ECOfelt - 90% Wolle, 10% Polyester	ACABADO DEL PANEL: • Trevira CS - 100% poliéster Reacción al fuego: CL1 Certificado: Oekotex • ECOfelt - 90% lana, 10% poliéster
RICICLABILITÀ: Pannello di materiale riciclato e riciclabile alla fine della sua vita, senza separare anima e finitura	RECYCLABILITY: Recycled material panel recyclable at the end of his life, without dividing soul and finish	RECYCLAGE: Panneau recyclé et recyclable en fin de vie, sans séparer les composants	RECYCLINGFÄHIGKEIT: Das Paneel besteht aus recyceltem Material und es kann wieder recycelt sein am Ende seines Leben	RECICLABILIDAD: Panel de material reciclado y reciclable al final de su vida, sin tener que separar el alma y el forro.
MANUTENZIONE: Pannello pulibile con detergenti specifici	MAINTENANCE: Cleanable panel with specific detergents	ENTRETIEN: Le panneau peut être nettoyé avec des détergents adaptés	INSTANDHALTUNG: Man kann das Paneel mit spezifischer Reinigungsmitteln säubern	MANTENIMIENTO: Panel limpiable con detergentes específicos.
REAZIONE AL FUOCO: B-s2, d0 	FIRE REACTION: B-s2, d0 	RÉACTION AU FEU: B-s2, d0 	Brandverhalten - Klasse: B-s2, d0 	REACCIÓN AL FUEGO: B-s2, d0 
MARCATURA CE: B-s1, d0 	CE MARK: B-s1, d0 	CE MARQ: B-s1, d0 	KENNZEICHNUNG CE: B-s1, d0 	MARCADO CE: B-s1, d0 
CERTIFICAZIONI ECOLOGICHE: GREENGUARD GREENGUARD GOLD 	GREEN LABELS: GREENGUARD GREENGUARD GOLD 	ÉTIQUETTES ÉCOLOGIQUE: GREENGUARD GREENGUARD GOLD 	ÖKOLOGISCHE ZERTIFIZIERUNG: GREENGUARD GREENGUARD GOLD 	CERTIFICACIONES ECOLÓGICAS: GREENGUARD GREENGUARDGOLD 
FONO ASSORBIMENTO: UNI EN ISO 354: 2003 UNI EN ISO 11654: 1998 	SOUND ABSORPTION: UNI EN ISO 354: 2003 UNI EN ISO 11654: 1998 	ABSORPTION DU SON: UNI EN ISO 354: 2003 UNI EN ISO 11654: 1998 	SCHALLABSORPTION: UNI EN ISO 354: 2003 UNI EN ISO 11654: 1998 	ABSORCIÓN DE SONIDO: UNI EN ISO 354: 2003 UNI EN ISO 11654: 1998 

Test su area equivalente / equivalent area test

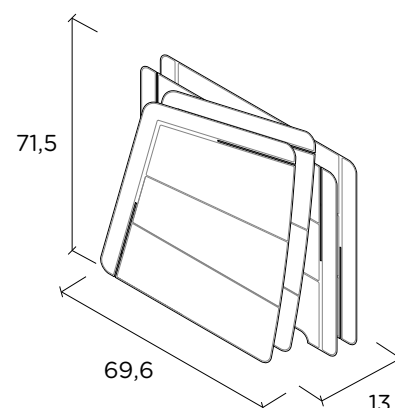



Axonometric view:

COD	EBOO-60.71
CM	60,4x69,6xH71,5
IN	23.8x27.4xH28.2
CO	CAT A (Tr, Ef)
€	

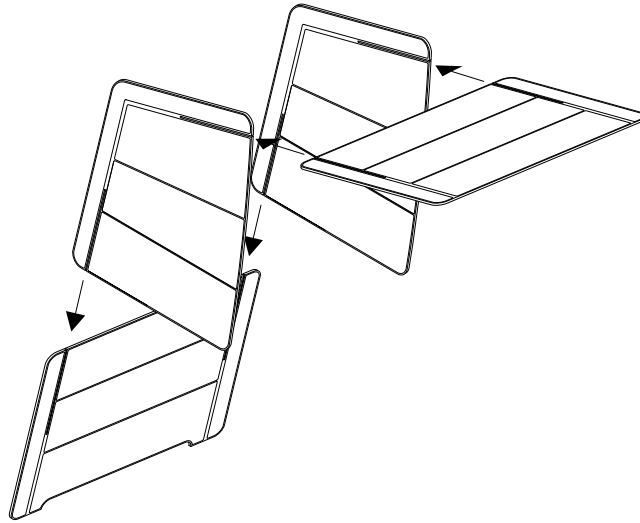

COD	EBOW-60.71
CM	60,4x69,6xH71,5
IN	23.8x27.4xH28.2
CO	CAT A (Tr, Ef)
€	



sistema aggancio a parete
Wall hooking system
Système de fixation mural
Wandhaken System
Sistema de enganche de pared

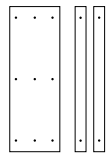

EBOW-HS
Bo

Axonometric view:

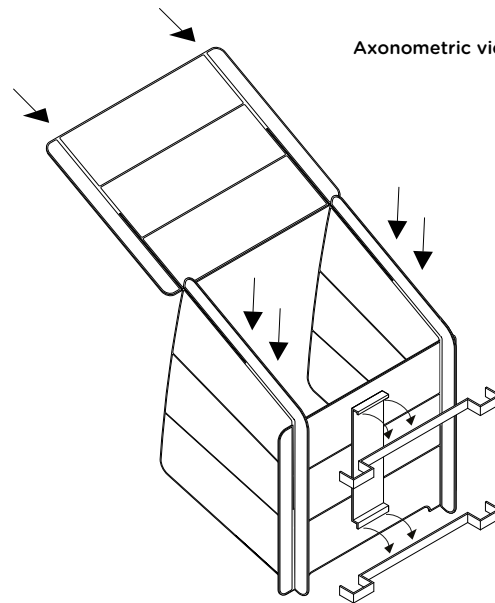

Ti piacciono i colori? Guarda le possibili soluzioni!
Do you like colors? Look at the possible solutions!

> 10 pezzi per colori CUSTOM
> 10 pieces for CUSTOMIZED colors

ECOfelt YELLOW 34

ECOfelt GREY 953

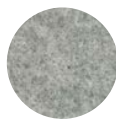

TREVIRA CS Beige 532

TREVIRA CS Peacock 411



Ti piace viaggiare? Do you like travel?

Disponibile borsa contenitore per ECObooth
container bag for ECObooth available
sac de conteneur pour ECObooth disponible
Containertasche für ECObooth verfügbar
bolsa de contenedor para ECObooth disponible

